

NCSA branch office

Name: AirTAC USA Corporation
Add: 21201 Park Row Drive, Katy, Texas, 77449, USA
Tel: +1-281-394-7177 **Fax:** +1-281-394-7199





















- NPT thread fittings
- NPT thread Silencer
- NPT thread Speed controller
- PT thread fittings
- PT thread Silencer
- PT thread Speed controller

























www.airtac.com







Global Automation Equipment Manufacturer's Long-term Strategic Partnership





















Type	Page	Conetction: Thread ↔ Tube		Type	Page	Conetction: Thread ↔ Tube																
		Thread	Tube O.D.(Inch)				Thread	Tube O.D.(mm)														
			1/8			5/32		1/4	5/16	3/8	1/2	4	6	8	10	12						
NPC Male connector 	7	U10 NPT1/8 NPT1/4 NPT3/8 NPT1/2	●	●	●	●	●	PC Male connector 	7	M5 PT1/8 PT1/4 PT3/8 PT1/2	●	●	●	●	●	●	●	●	●	●	●	●
NPL Male elbow 	7	U10 NPT1/8 NPT1/4 NPT3/8 NPT1/2	●	●	●	●	●	PL Male elbow 	7	M5 PT1/8 PT1/4 PT3/8 PT1/2	●	●	●	●	●	●	●	●	●	●	●	●
NPLL Extended male elbow 	8	U10 NPT1/8 NPT1/4 NPT3/8 NPT1/2	●	●	●	●	●	PLL Extended male elbow 	8	M5 PT1/8 PT1/4 PT3/8 PT1/2	●	●	●	●	●	●	●	●	●	●	●	●
NPYB Branch "Y" 	8	U10 NPT1/8 NPT1/4 NPT3/8 NPT1/2	●	●	●	●	●	PYB Branch "Y" 	8	M5 PT1/8 PT1/4 PT3/8 PT1/2	●	●	●	●	●	●	●	●	●	●	●	●
NPZB Threaded cross 	8	U10 NPT1/8 NPT1/4 NPT3/8 NPT1/2	●	●	●	●	●	PZB Threaded cross 	8	M5 PT1/8 PT1/4 PT3/8 PT1/2	●	●	●	●	●	●	●	●	●	●	●	●
NPEB Male branch tee 	9	U10 NPT1/8 NPT1/4 NPT3/8 NPT1/2	●	●	●	●	●	PEB Male branch tee 	9	M5 PT1/8 PT1/4 PT3/8 PT1/2	●	●	●	●	●	●	●	●	●	●	●	●
NPED Male run tee 	9	U10 NPT1/8 NPT1/4 NPT3/8 NPT1/2	●	●	●	●	●	PED Male run tee 	9	M5 PT1/8 PT1/4 PT3/8 PT1/2	●	●	●	●	●	●	●	●	●	●	●	●
NPHW Double universal male elbow 	9	U10 NPT1/8 NPT1/4 NPT3/8 NPT1/2	●	●	●	●	●	PHW Double universal male elbow 	9	M5 PT1/8 PT1/4 PT3/8 PT1/2	●	●	●	●	●	●	●	●	●	●	●	●
NPH Universal male elbow 	10	U10 NPT1/8 NPT1/4 NPT3/8 NPT1/2	●	●	●	●	●	PH Universal male elbow 	10	M5 PT1/8 PT1/4 PT3/8 PT1/2	●	●	●	●	●	●	●	●	●	●	●	●
NPHF Universal female elbow 	10	U10 NPT1/8 NPT1/4 NPT3/8 NPT1/2	●	●	●	●	●	PHF Universal female elbow 	10	M5 PT1/8 PT1/4 PT3/8 PT1/2	●	●	●	●	●	●	●	●	●	●	●	●



Type	Page	Conetction: Thread ↔ Tube		Type	Page	Conetction: Thread ↔ Tube															
		Thread	Tube O.D.(Inch)				Thread	Tube O.D.(mm)													
			1/8			5/32		1/4	5/16	3/8	1/2	4	6	8	10	12					
NPMF Bulkhead connector 	10	U10 NPT1/8 NPT1/4 NPT3/8 NPT1/2	●	●	●	●	●	PMF Bulkhead connector 	10	M5 PT1/8 PT1/4 PT3/8 PT1/2	●	●	●	●	●	●	●	●	●	●	●
NPLF Female elbow 	11	U10 NPT1/8 NPT1/4 NPT3/8 NPT1/2	●	●	●	●	●	PLF Female elbow 	11	M5 PT1/8 PT1/4 PT3/8 PT1/2	●	●	●	●	●	●	●	●	●	●	●
NPCF Female connector 	11	U10 NPT1/8 NPT1/4 NPT3/8 NPT1/2	●	●	●	●	●	PCF Female connector 	11	M5 PT1/8 PT1/4 PT3/8 PT1/2	●	●	●	●	●	●	●	●	●	●	●
NBPC Metal male connector 	12	U10 NPT1/8 NPT1/4 NPT3/8 NPT1/2	●	●	●	●	●	BPC Metal male connector 	12	M5 PT1/8 PT1/4 PT3/8 PT1/2	●	●	●	●	●	●	●	●	●	●	●
NBPCF Metal female connector 	12	U10 NPT1/8 NPT1/4 NPT3/8 NPT1/2	●	●	●	●	●	BPCF Metal female connector 	12	M5 PT1/8 PT1/4 PT3/8 PT1/2	●	●	●	●	●	●	●	●	●	●	●
NBPMF Metal bulkhead female connector 	12	U10 NPT1/8 NPT1/4 NPT3/8 NPT1/2	●	●	●	●	●	BPMF Metal bulkhead female connector 	12	M5 PT1/8 PT1/4 PT3/8 PT1/2	●	●	●	●	●	●	●	●	●	●	●
NBKC Straight locknut connector 	13	U10 NPT1/8 NPT1/4 NPT3/8 NPT1/2	●	●	●	●	●	BKC Straight locknut connector 	13	M5 PT1/8 PT1/4 PT3/8 PT1/2	●	●	●	●	●	●	●	●	●	●	●
NPTL Speed Control valve 	18	U10 NPT1/8 NPT1/4 NPT3/8 NPT1/2	●	●	●	●	●	PTL Mini Speed Control valve 	18	M5 PT1/8 PT1/4 PT3/8 PT1/2	●	●	●	●	●	●	●	●	●	●	●
NPSS Speed Control valve 	18	U10 NPT1/8 NPT1/4 NPT3/8 NPT1/2	●	●	●	●	●	PSS Speed Control valve 	18	M5 PT1/8 PT1/4 PT3/8 PT1/2	●	●	●	●	●	●	●	●	●	●	●
NPSS Speed Control valve 	18	U10 NPT1/8 NPT1/4 NPT3/8 NPT1/2	●	●	●	●	●	PSL Speed Control valve 	19	M5 PT1/8 PT1/4 PT3/8 PT1/2	●	●	●	●	●	●	●	●	●	●	●



















Contection: Thread ↔ Tube															
Type	Page	Thread	Tube O.D.(mm)					Type	Page	Thread	Tube O.D.(mm)				
			4	6	8	10	12				4	6	8	10	12
BPOC Hexagon socket head metal male connector 	13	M5						POC Hexagon socket head male connector 	13	M5					
		PT1/8	●	●	●					PT1/8	●	●	●		
		PT1/4		●	●	●				PT1/4	●	●	●	●	
		PT3/8				●	●			PT3/8		●	●	●	●
		PT1/2					●			PT1/2			●	●	●

Contection: Thread ↔ Thread												
Type	Page	Thread I(NPT)	Thread II(NPT)			Type	Page	Thread II(PT)	Thread II(PT)			
			1/8	1/4	3/8				1/2	1/8	1/4	3/8
NBD Male & female connector 	14	1/8		●	●	●	BD Male & female connector 	1/8		●	●	●
		1/4			●	●		1/4			●	●
		3/8				●		3/8				●
		1/2						1/2				
NBU Double female connector 	14	1/8	●				BU Double female connector 	1/8	●			
		1/4		●				1/4		●		
		3/8			●			3/8			●	
		1/2				●		1/2				●
NBB Male connector 	13	1/8	●	●	●	●	BB Male connector 	1/8	●	●	●	●
		1/4		●	●	●		1/4		●	●	●
		3/8			●	●		3/8			●	●
		1/2				●		1/2				●

Contection: Tube ↔ Tube													
Type	Page	Tube(Inch)					Type	Page	Tube(mm)				
		5/32	1/4	5/16	3/8	1/2			4	6	8	10	12
NPU Straight union 	15	●	●	●	●	●	PU Straight union 	15	●	●	●	●	●
NPY Union "Y" 	15	●	●	●	●	●	PY Union "Y" 	15	●	●	●	●	●
NPM Bulkhead union 	15	●	●	●	●	●	PM Bulkhead union 	15	●	●	●	●	●
NPZ Bulkhead union 	15	●	●	●	●	●	PZ Bulkhead union 	15	●	●	●	●	●
NPV Union elbow 	15	●	●	●	●	●	PV Union elbow 	15	●	●	●	●	●
NPE Union tee 	15	●	●	●	●	●	PE Union tee 	15	●	●	●	●	●
NPP Plug 	15	●	●	●	●	●	PP Plug 	15	●	●	●	●	●
NPLM Bulkhead male elbow 	15	●	●	●	●	●	PLM Bulkhead male elbow 	15	●	●	●	●	●
NPSA Speed Control valve 	19	●	●	●	●	●							

Contection: Thread ↔ Tube(ΦDA-ΦDB)											
Type	Page	Thread	Tube(Inch)			Type	Page	Thread	Tube(mm)		
			1/4-5/32	5/16-1/4	3/8-5/16				6-4	8-6	10-8
NPKD Male reducer triple branch 	11	NPT1/8	●			PKD Male reducer triple branch 	11	PT1/8	●		
		NPT1/4		●				PT1/4		●	
		NPT3/8			●			PT3/8			●
		NPT1/2						PT1/2			

Contection: Tube ↔ Tube													
Type	Page	Tube(Inch)					Type	Page	Tube(Inch)				
		5/32	1/4	5/16	3/8	1/2			5/32	1/4	5/16	3/8	1/2
NBPM Metal bulkhead connector 	12	●	●	●	●	●	NPHV Finger valve 	19	●	●	●	●	●

Contection: Tube I ↔ TubeII														
Type	Page	Tube I (Inch)	Tube II(Inch)				Type	Page	Tube I (mm)	Tube II(mm)				
			5/32	1/4	5/16	3/8				4	6	8	10	
NPG Different diameter straight 	16	1/4	●				PG Different diameter straight 	16	6	●				
		5/16		●					8	●	●			
		3/8			●				10		●	●		
		1/2				●			●	12			●	●
NPEW Different diameter tee 	16	1/4	●				PEW Different diameter tee 	16	6	●				
		5/16		●					8		●			
		3/8			●				10			●		
		1/2				●			●	12			●	●
NPEG Different diameter tee 	16	1/4	●				PEG Different diameter tee 	16	6	●				
		5/16		●					8		●			
		3/8			●				10			●		
		1/2				●			●	12			●	●
NPKG Reducer triple branch union 	16	1/4	●				PKG Reducer triple branch union 	16	6	●				
		5/16		●					8		●			
		3/8			●				10			●		
		1/2				●			●	12			●	●
NPHD Universal reducer four branch union 	16	1/4		●			PHD Universal reducer four branch union 	16	6		●			
		5/16			●				8			●		
		3/8				●				10				●
		1/2							●	●	12			
NPGJ Plug-in reducer 	17	1/4	●				PGJ Plug-in reducer 	17	6	●				
		5/16		●					8	●	●			
		3/8			●				10			●		
		1/2				●			●	12			●	●
NPZG Different diameter cross 	17	1/4	●				PZG Different diameter cross 	17	6	●				
		5/16		●					8		●			
		3/8			●				10			●		
		1/2				●			●	12				●
NPYW Different diameter union "Y" 	17	1/4	●				PYW Different diameter union "Y" 	17	6	●				
		5/16		●					8		●			
		3/8			●				10			●		
		1/2				●			●	12			●	●
NPHK Universal reducer triple branch union 	17	1/4		●			PHK Universal reducer triple branch union 	17	6		●			
		5/16			●				8			●		
		3/8				●				10				●
		1/2				●	●	12				●		

Conetction: Thread							
Type	Page	Thread		Type	Page	Thread	
NBZ Hexagon head cap plug 	14	NPT1/8	●	BZ Hexagon head cap plug 	14	PT1/8	●
		NPT1/4	●			PT1/4	●
		NPT3/8	●			PT3/8	●
		NPT1/2	●			PT1/2	●

Silencers: Thread							
Type	Page	Thread		Type	Page	Thread	
NBSL Silencers 	19	U10	●	BSL Silencers 	19	M5	●
		NPT1/8	●			PT1/8	●
		NPT1/4	●			PT1/4	●
		NPT3/8	●			PT3/8	●
NBSLM Silencers 	19	U10	●	BSLM Silencers 	19	M5	●
		NPT1/8	●			PT1/8	●
		NPT1/4	●			PT1/4	●
		NPT3/8	●			PT3/8	●
NBESL Silencers 	19	NPT1/8	●	BESL Silencers 	19	PT1/8	●
		NPT1/4	●			PT1/4	●
		NPT3/8	●			PT3/8	●
		NPT1/2	●			PT1/2	●
PAL Silencers 	19	PT1/8	●	PALM Silencers 	19	PT1/8	●
		PT1/4	●			PT1/4	●
		PT3/8	●			PT3/8	●
		PT1/2	●			PT1/2	●

Re-coil hosepart & Flame resistant tube: Tube ΦO.D ↔ Tube ΦI.D																	
Type	Page	ΦI.D (Inch)	ΦO.D(Inch)						Type	Page	ΦI.D (mm)	ΦO.D(mm)					
			1/8	5/32	1/4	5/16	3/8	1/2				4	6	8	10	12	16
NUE95A Polyurethane re-coil hosepart 	20	5/64	●					UE95A Polyurethane re-coil hosepart 	20	2.5	●						
		3/32	●							4	●						
		5/32	●							5	●	●					
		1/5		●						5.5	●	●					
		1/4			●					6.5	●	●	●				
		1/3				●				8	●	●	●	●			
US98A Polyurethane re-coil hosepart 	20	2.5						PA6\PA12 Nylon tube 	20	2.5	●						
		4								4	●						
		5								5	●	●					
		5.5								5.5	●	●	●				
		6								6	●	●	●				
		6.5								6.5	●	●	●	●			
		8								8	●	●	●	●			
		10								10	●	●	●	●	●		
11						11					●						
12						12					●						

Application:

- One-touch fittings used for pneumatic piping;
- Wide variety of models available to meet all needs.

Features:

- Elliptical sleeve allows easy connect/disconnect by one touch;
- Straight fitting type useful for piping in confined space by fastening through internal hex;
- Fittings include NBR O-ring and Teflon treated threads.

One-touch fittings(Thread ↔ Tube)

PRODUCT CODE SYSTEM

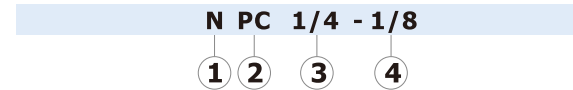

- ① Thread type
No code=PT thread N=NTP thread
- ② Model
- ③ Tube Diameter (ΦD)

Imperial Sizes		Metric Sizes	
Code	Dia	Code	Dia
1/8	1/8"	3. 2	3. 2mm
5/32	5/32"	4	4mm
1/4	1/4"	6	6mm
5/16	5/16"	8	8mm
3/8	3/8"	10	10mm
1/2	1/2"	12	12mm

- ④ Thread sizes(R)

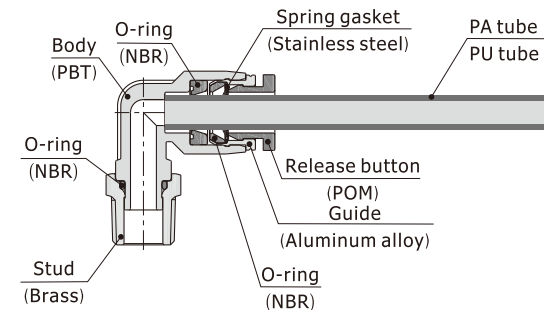

Imperial Sizes		Metric Sizes	
Code	NPT Thread	Code	PT Thread
U10	#10-32UNF		
1/8	NPT1/8	01	PT1/8
1/4	NPT1/4	02	PT1/4
3/8	NPT3/8	03	PT3/8
1/2	NPT1/2	04	PT1/2

STRUCTURAL DIAGRAM





Specifications	
Operating pressure range	0~10kgf/cm ² (0~1.0MPa)
Negative pressure	-750mmHg(10Torr)
Proof pressure	1.5MPa
Ambient and fluid temperature (°C)	-20~70
Applicable tubing	Soft nylon or polyurethane
Color	Blue/Gray







Threaded type

		Model+ Φ D+R				
Φ D(Inch)	R(NPT thread)	PCS/bag	Φ D(Metric)	R(PT thread)	PCS/bag	
NPC Male connector			PC Male connector			
	NPC1/8-U10	10	PC401		10	
	NPC5/32-U10	10	PC402		10	
	NPC5/32-1/8	10	PC601		10	
	NPC1/4-U10	10	PC602		10	
	NPC1/4-1/8	10	PC603		10	
	NPC1/4-1/4	10	PC604		10	
	NPC1/4-3/8	10	PC801		10	
	NPC5/16-1/8	10	PC802		10	
	NPC5/16-1/4	10	PC803		10	
	NPC5/16-3/8	10	PC804		10	
	NPC3/8-1/8	10	PC1001		10	
	NPC3/8-1/4	10	PC1002		10	
	NPC3/8-3/8	10	PC1003		10	
	NPC3/8-1/2	10	PC1004		10	
	NPC1/2-1/4	10	PC1201		10	
	NPC1/2-3/8	10	PC1202		10	
	NPC1/2-1/2	10	PC1204		10	
				Mini type		
				PC401-M		10
			PC601-M		10	
Φ D(Inch)	R(NPT thread)	PCS/bag	Φ D(Metric)	R(PT thread)	PCS/bag	
NPL Male elbow			PL Male elbow			
	NPL1/8-U10	10	PL401		10	
	NPL5/32-U10	10	PL402		10	
	NPL5/32-1/8	10	PL601		10	
	NPL1/4-U10	10	PL602		10	
	NPL1/4-1/8	10	PL603		10	
	NPL1/4-1/4	10	PL604		10	
	NPL1/4-3/8	10	PL801		10	
	NPL5/16-1/8	10	PL802		10	
	NPL5/16-1/4	10	PL803		10	
	NPL5/16-3/8	10	PL804		10	
	NPL3/8-1/8	10	PL1001		10	
	NPL3/8-1/4	10	PL1002		10	
	NPL3/8-3/8	10	PL1003		10	
	NPL3/8-1/2	10	PL1004		10	
	NPL1/2-1/4	10	PL1201		10	
	NPL1/2-3/8	10	PL1202		10	
	NPL1/2-1/2	10	PL1204		10	
				Mini type		
				PL401-M		10
			PL601-M		10	







Threaded type

		Model+ Φ D+R				
Φ D(Inch)	R(NPT thread)	PCS/bag	Φ D(Metric)	R(PT thread)	PCS/bag	
NPLL Extended male elbow			PLL Extended male elbow			
	NPLL5/32-U10	10	PLL401		10	
	NPLL5/32-1/8	10	PLL402		10	
	NPLL1/4-U10	10	PLL601		10	
	NPLL1/4-1/8	10	PLL602		10	
	NPLL1/4-1/4	10	PLL603		10	
	NPLL1/4-3/8	10	PLL801		10	
	NPLL5/16-1/8	10	PLL802		10	
	NPLL5/16-1/4	10	PLL803		10	
	NPLL5/16-3/8	10	PLL1001		10	
	NPLL3/8-1/8	10	PLL1002		10	
	NPLL3/8-1/4	10	PLL1003		10	
	NPLL3/8-3/8	10	PLL1004		10	
	NPLL3/8-1/2	10	PLL1202		10	
	NPLL1/2-1/4	10	PLL1203		10	
	NPLL1/2-3/8	10	PLL1204		10	
	NPLL1/2-1/2	10				
	Φ D(Inch)	R(NPT thread)	PCS/bag	Φ D(Metric)	R(PT thread)	PCS/bag
	NPYB Branch "Y"			PYB Branch "Y"		
		NPYB5/32-U10	10	PYB401		10
NPYB5/32-1/8		10	PYB402		10	
NPYB1/4-U10		10	PYB601		10	
NPYB1/4-1/8		10	PYB602		10	
NPYB1/4-1/4		10	PYB603		10	
NPYB1/4-3/8		10	PYB801		10	
NPYB5/16-1/8		10	PYB802		10	
NPYB5/16-1/4		10	PYB803		10	
NPYB5/16-3/8		10	PYB804		10	
NPYB3/8-1/8		10	PYB1001		10	
NPYB3/8-1/4		10	PYB1002		10	
NPYB3/8-3/8		10	PYB1003		10	
NPYB3/8-1/2		10	PYB1004		10	
NPYB1/2-1/4		10	PYB1202		10	
NPYB1/2-3/8		10	PYB1203		10	
NPYB1/2-1/2		10	PYB1204		10	
Φ D(Inch)		R(NPT thread)	PCS/bag	Φ D(Metric)	R(PT thread)	PCS/bag
NPZB Threaded cross			PZB Threaded cross			
		NPZB1/4-1/8	10	PZB601		10
	NPZB1/4-1/4	10	PZB602		10	
	NPZB1/4-3/8	10	PZB603		10	
	NPZB5/16-1/8	10	PZB801		10	
	NPZB5/16-1/4	10	PZB802		10	
	NPZB5/16-3/8	10	PZB803		10	
	NPZB3/8-1/4	10	PZB804		10	
	NPZB3/8-3/8	10	PZB1002		10	
	NPZB3/8-1/2	10	PZB1003		10	
	NPZB1/2-3/8	10	PZB1004		10	
	NPZB1/2-1/2	10	PZB1203		10	
				PZB1204		10







Threaded type

		Model+ΦD+R				Model+ΦD+R	
ΦD(Inch)	R(NPT thread)	PCS/bag	ΦD(Metric)	R(PT thread)	PCS/bag	ΦD(Inch)	R(NPT thread)
NPEB Male branch tee			PEB Male branch tee				
	NPEB5/32-U10	10		PEB401	10		
	NPEB5/32-1/8	10		PEB402	10		
	NPEB1/4-U10	10		PEB601	10		
	NPEB1/4-1/8	10		PEB602	10		
	NPEB1/4-1/4	10		PEB603	10		
	NPEB1/4-3/8	10		PEB801	10		
	NPEB5/16-1/8	10		PEB802	10		
	NPEB5/16-1/4	10		PEB803	10		
	NPEB5/16-3/8	10		PEB804	10		
	NPEB3/8-1/8	10		PEB1001	10		
	NPEB3/8-1/4	10		PEB1002	10		
	NPEB3/8-3/8	10		PEB1003	10		
	NPEB3/8-1/2	10		PEB1004	10		
	NPEB1/2-1/4	10		PEB1202	10		
	NPEB1/2-3/8	10		PEB1203	10		
	NPEB1/2-1/2	10		PEB1204	10		
ΦD(Inch)	R(NPT thread)	PCS/bag	ΦD(Metric)	R(PT thread)	PCS/bag	ΦD(Inch)	R(NPT thread)
NPED Male run tee			PED Male run tee				
	NPED5/32-U10	10		PED401	10		
	NPED5/32-1/8	10		PED402	10		
	NPED1/4-U10	10		PED601	10		
	NPED1/4-1/8	10		PED602	10		
	NPED1/4-1/4	10		PED603	10		
	NPED1/4-3/8	10		PED801	10		
	NPED5/16-1/8	10		PED802	10		
	NPED5/16-1/4	10		PED803	10		
	NPED5/16-3/8	10		PED804	10		
	NPED3/8-1/8	10		PED1001	10		
	NPED3/8-1/4	10		PED1002	10		
	NPED3/8-3/8	10		PED1003	10		
	NPED3/8-1/2	10		PED1004	10		
	NPED1/2-1/4	10		PED1202	10		
	NPED1/2-3/8	10		PED1203	10		
	NPED1/2-1/2	10		PED1204	10		
ΦD(Inch)	R(NPT thread)	PCS/bag	ΦD(Metric)	R(PT thread)	PCS/bag	ΦD(Inch)	R(NPT thread)
NPHW Double universal male elbow			PHW Double universal male elbow				
	NPHW5/32-1/8	10		PHW401	10		
	NPHW1/4-1/8	10		PHW601	10		
	NPHW1/4-1/4	10		PHW602	10		
	NPHW1/4-3/8	5		PHW603	5		
	NPHW5/16-1/8	10		PHW801	10		
	NPHW5/16-1/4	10		PHW802	10		
	NPHW5/16-3/8	5		PHW803	5		
	NPHW3/8-1/4	10		PHW804	5		
	NPHW3/8-3/8	5		PHW1002	10		
	NPHW3/8-1/2	5		PHW1003	5		
	NPHW1/2-3/8	5		PHW1004	5		
	NPHW1/2-1/2	5		PHW1203	5		
				PHW1204	5		







Threaded type

		Model+ΦD+R				Model+ΦD+R	
ΦD(Inch)	R(NPT thread)	PCS/bag	ΦD(Metric)	R(PT thread)	PCS/bag	ΦD(Inch)	R(NPT thread)
NPH Universal male elbow			PH Universal male elbow				
	NPH5/32-U10	10		PH401	10		
	NPH5/32-1/8	10		PH601	10		
	NPH1/4-U10	10		PH602	10		
	NPH1/4-1/8	10		PH603	5		
	NPH1/4-1/4	10		PH801	10		
	NPH1/4-3/8	5		PH802	10		
	NPH5/16-1/8	10		PH803	5		
	NPH5/16-1/4	10		PH804	5		
	NPH5/16-3/8	5		PH1002	10		
	NPH3/8-1/4	5		PH1003	5		
	NPH3/8-3/8	5		PH1004	5		
	NPH3/8-1/2	5		PH1203	5		
	NPH1/2-3/8	5		PH1204	5		
	NPH1/2-1/2	5					
ΦD(Inch)	R(NPT thread)	PCS/bag	ΦD(Metric)	R(PT thread)	PCS/bag	ΦD(Inch)	R(NPT thread)
NPHF Universal female elbow			PHF Universal female elbow				
	NPHF5/32-U10	10		PHF401	10		
	NPHF5/32-1/8	10		PHF601	10		
	NPHF1/4-U10	10		PHF602	10		
	NPHF1/4-1/8	10		PHF603	5		
	NPHF1/4-1/4	10		PHF801	10		
	NPHF1/4-3/8	5		PHF802	10		
	NPHF5/16-1/8	10		PHF803	5		
	NPHF5/16-1/4	10		PHF804	5		
	NPHF5/16-3/8	5		PHF1002	10		
	NPHF3/8-1/4	5		PHF1003	5		
	NPHF3/8-3/8	5		PHF1004	5		
	NPHF3/8-1/2	5		PHF1203	5		
	NPHF1/2-3/8	5		PHF1204	5		
	NPHF1/2-1/2	5					
ΦD(Inch)	R(NPT thread)	M(Inch)	PCS/bag	ΦD(Metric)	R(PT thread)	M(Metric)	PCS/bag
NPMF Bulkhead connector				PMF Bulkhead connector			
	NPMF5/32-1/8	1/2-20UNF	10		PMF401	M12X1	10
	NPMF1/4-1/8	9/16-18UNF	10		PMF402	M12X1	10
	NPMF1/4-1/4	9/16-18UNF	10		PMF601	M14X1	10
	NPMF1/4-3/8	9/16-18UNF	10		PMF602	M14X1	10
	NPMF5/16-1/8	5/8-18UNF	10		PMF603	M14X1	10
	NPMF5/16-1/4	5/8-18UNF	10		PMF801	M16X1	10
	NPMF5/16-3/8	5/8-18UNF	10		PMF802	M16X1	10
	NPMF3/8-1/8	7/8-14UNF	10		PMF803	M16X1	10
	NPMF3/8-1/4	7/8-14UNF	10		PMF804	M16X1	10
	NPMF3/8-3/8	7/8-14UNF	10		PMF1001	M20X1	10
	NPMF3/8-1/2	7/8-14UNF	10		PMF1002	M20X1	10
	NPMF1/2-1/4	7/8-14UNF	10		PMF1003	M20X1	10
	NPMF1/2-3/8	7/8-14UNF	10		PMF1004	M20X1	10
	NPMF1/2-1/2	7/8-14UNF	10		PMF1202	M22X1	10
					PMF1203	M22X1	10
					PMF1204	M22X1	10



Threaded type

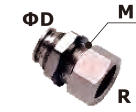

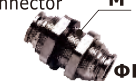
		Model+ΦD+R				Model+ΦDA-ΦDB+R				
		ΦD(Inch)R(NPT thread)	PCS/bag	ΦD(Metric) R(PT thread)	PCS/bag	ΦDA(Inch)ΦDB(Inch)R(NPT thread)	PCS/bag	ΦDA(Metric) ΦDB(Metric)R(PT thread)	PCS/bag	
NPLF Female elbow 		NPLF5/32-U10	10	PLF Female elbow 						
		NPLF5/32-1/8	10			PLF401	10			
		NPLF1/4-U10	10			PLF402	10			
		NPLF1/4-1/8	10			PLF601	10			
		NPLF1/4-1/4	10			PLF602	10			
		NPLF1/4-1/4	10			PLF603	10			
		NPLF1/4-3/8	10			PLF801	10			
		NPLF5/16-1/8	10			PLF802	10			
		NPLF5/16-1/4	10			PLF803	10			
		NPLF5/16-3/8	10			PLF804	10			
		NPLF3/8-1/8	10			PLF1001	10			
		NPLF3/8-1/4	10			PLF1002	10			
		NPLF3/8-3/8	10			PLF1003	10			
		NPLF3/8-1/2	10			PLF1004	10			
		NPLF1/2-1/4	10			PLF1202	10			
	NPLF1/2-3/8	10		PLF1203	10					
	NPLF1/2-1/2	10		PLF1204	10					
NPCF Female connector 		NPCF5/32-U10	10	PCF Female connector 						
		NPCF5/32-1/8	10			PCF401	10			
		NPCF1/4-U10	10			PCF402	10			
		NPCF1/4-1/8	10			PCF601	10			
		NPCF1/4-1/4	10			PCF602	10			
		NPCF1/4-1/4	10			PCF603	10			
		NPCF1/4-3/8	10			PCF604	10			
		NPCF5/16-1/8	10			PCF801	10			
		NPCF5/16-1/4	10			PCF802	10			
		NPCF5/16-3/8	10			PCF803	10			
		NPCF3/8-1/8	10			PCF804	10			
		NPCF3/8-1/4	10			PCF1001	10			
		NPCF3/8-3/8	10			PCF1002	10			
		NPCF3/8-1/2	10			PCF1003	10			
		NPCF1/2-1/4	10			PCF1004	10			
	NPCF1/2-3/8	10		PCF1202	10					
	NPCF1/2-1/2	10		PCF1203	10					
				PCF1204	10					
NPKD Male reducer triple branch 		NPKD1/4-5/32-1/8	2	PKD Male reducer triple branch 						
		NPKD5/16-1/4-1/4	2			PKD6-401	2			
		NPKD3/8-5/16-3/8	2			PKD8-602	2			
						PKD10-803	2			



Threaded type

		Model+ΦD+R				Model+ΦD		
		ΦD(Inch)R(NPT thread)	PCS/bag	ΦD(Metric)R(PT thread)	PCS/bag	ΦD(Inch) M(Inch)	PCS/bag	
NBPC Metal male connector 		NBPC5/32-U10	10	BPC Metal male connector 				
		NBPC5/32-1/8	10			BPC401	10	
		NBPC1/4-U10	10			BPC402	10	
		NBPC1/4-1/8	10			BPC601	10	
		NBPC1/4-1/4	10			BPC602	10	
		NBPC1/4-1/4	10			BPC603	10	
		NBPC1/4-3/8	10			BPC801	10	
		NBPC5/16-1/8	10			BPC802	10	
		NBPC5/16-1/4	10			BPC803	10	
		NBPC5/16-3/8	10			BPC1001	10	
		NBPC3/8-1/8	10			BPC1002	10	
		NBPC3/8-1/4	10			BPC1003	10	
		NBPC3/8-3/8	10			BPC1004	10	
		NBPC3/8-1/2	10			BPC1202	10	
		NBPC1/2-1/4	10			BPC1203	10	
	NBPC1/2-3/8	10		BPC1204	10			
	NBPC1/2-1/2	10						
NBPCF Metal female connector 		NBPCF5/32-U10	10	BPCF Metal female connector 				
		NBPCF5/32-1/8	10			BPCF401	10	
		NBPCF1/4-U10	10			BPCF601	10	
		NBPCF1/4-1/8	10			BPCF602	10	
		NBPCF1/4-1/4	10			BPCF801	10	
		NBPCF1/4-1/4	10			BPCF802	10	
		NBPCF5/16-1/8	10			BPCF1002	10	
		NBPCF5/16-1/4	10			BPCF1003	10	
		NBPCF3/8-1/4	10			BPCF1203	10	
		NBPCF3/8-3/8	10			BPCF1204	10	
	NBPCF1/2-3/8	10						
	NBPCF1/2-1/2	10						
NBPMF Metal bulkhead female connector 		NBPMF5/32-1/8 1/2-20UNF	10	BPMF Metal bulkhead female connector 				
		NBPMF1/4-1/8 9/16-18UNF	10			BPMF401 M12X1	10	
		NBPMF1/4-1/4 9/16-18UNF	10			BPMF601 M14X1	10	
		NBPMF5/16-1/8 5/8-18UNF	10			BPMF602 M14X1	10	
		NBPMF5/16-1/4 5/8-18UNF	10			BPMF801 M16X1	10	
		NBPMF3/8-1/4 7/8-14UNF	10			BPMF802 M16X1	10	
		NBPMF3/8-3/8 7/8-14UNF	10			BPMF1002 M20X1	10	
		NBPMF1/2-3/8 7/8-14UNF	10			BPMF1003 M20X1	10	
	NBPMF1/2-1/2 7/8-14UNF	10		BPMF1203 M22X1	10			
				BPMF1204 M22X1	10			
NBPM Metal bulkhead connector 		NBPM5/32 1/2-20UNF	10					
		NBPM1/4 9/16-18UNF	10					
		NBPM5/16 5/8-18UNF	10					
		NBPM3/8 7/8-14UNF	10					
		NBPM1/2 7/8-14UNF	10					



Threaded type



Model+ΦD+R			Model+ΦD+R		
ΦD(Metric)R(PT thread)	PCS/bag		ΦD(Metric)R(PT thread)	PCS/bag	
POC Hexagon socket head male connector 	POC401	10	BPOC Hexagon socket head metal male connector 	BPOC401	10
	POC402	10		BPOC601	10
	POC601	10		BPOC602	10
	POC602	10		BPOC801	10
	POC801	10		BPOC802	10
	POC802	10		BPOC1002	10
	POC803	10		BPOC1003	10
	POC1001	10		BPOC1203	10
	POC1002	10		BPOC1204	10
	POC1003	10			
	POC1004	10			
	POC1202	10			
	POC1203	10			
	POC1204	10			



Model+ΦO.D+ΦI.D-R					
ΦO.D(Inch)R(NPT thread)	PCS/bag		ΦO.D(Metric)ΦI.D(Metric) R(PT thread)	PCS/bag	
NBKC Straight locknut connector 	NBKC5/32-U10	10	BKC Straight locknut connector 	BKC0425-01	10
	NBKC5/32-1/8	10		BKC0604-01	10
	NBKC1/4-1/8	10		BKC0604-02	10
	NBKC1/4-1/4	10		BKC0604-03	10
	NBKC1/4-3/8	10		BKC0805-01	10
	NBKC5/16-1/8	10		BKC0805-02	10
	NBKC5/16-1/4	10		BKC0805-03	10
	NBKC5/16-3/8	10		BKC0806-01	10
	NBKC3/8-1/4	10		BKC0806-02	10
	NBKC3/8-3/8	10		BKC0806-03	10
	NBKC3/8-1/2	10		BKC1065-02	10
	NBKC1/2-1/4	10		BKC1065-03	10
	NBKC1/2-3/8	10		BKC1065-04	10
	NBKC1/2-1/2	10		BKC1075-02	10
				BKC1075-03	10
				BKC1075-04	10
				BKC1208-02	10
				BKC1208-03	10
				BKC1208-04	10
		BKC1209-02	10		
		BKC1209-03	10		
		BKC1209-04	10		

Model+RA+RB					
RA(NPT thread)	RB(NPT thread)	PCS/bag	RA(PT thread)	RB(PT thread)	PCS/bag
NBB Male connector 	NBB1/8-1/8	10	BB Male connector 	BB0101	10
	NBB1/8-1/4	10		BB0102	10
	NBB1/8-3/8	10		BB0103	10
	NBB1/4-1/4	10		BB0202	10
	NBB1/4-3/8	10		BB0203	10
	NBB1/4-1/2	10		BB0204	10
	NBB3/8-3/8	10		BB0303	10
	NBB3/8-1/2	10		BB0304	10
	NBB1/2-1/2	10		BB0404	10

















Threaded type

Model+RA+RB					
RA(NPT thread)	RB(NPT thread)	PCS/bag	RA(PT thread)	RB(PT thread)	PCS/bag
NBD Male & female connector 	NBD1/8-1/4	10	BD Male & female connector 	BD0102	10
	NBD1/8-3/8	10		BD0103	10
	NBD1/8-1/2	10		BD0104	10
	NBD1/4-3/8	10		BD0203	10
	NBD1/4-1/2	10		BD0204	10
	NBD3/8-1/2	10		BD0304	10





Model+R					
	R(NPT thread)	PCS/bag		R(PT thread)	PCS/bag
NBU Double female connector 	NBU1/8-1/8	10	BU Double female connector 	BU0101	10
	NBU1/4-1/4	10		BU0202	10
	NBU3/8-3/8	10		BU0303	10
	NBU1/2-1/2	10		BU0404	10

Model+R			Model+R		
	R(NPT thread)	PCS/bag		R(PT thread)	PCS/bag
NBZ Hexagon head cap plug 	NBZ1/8	10	BZ Hexagon head cap plug 	BZ01	10
	NBZ1/4	10		BZ02	10
	NBZ3/8	10		BZ03	10
	NBZ1/2	10		BZ04	10









Tube-tube type



Model+ΦD							
	ΦD(Inch)	PCS/bag		ΦD(Metric)	PCS/bag		
NPU Straight union 	NPU5/32	10	PU Straight union 	PU4	10		
	NPU1/4	10		PU6	10		
	NPU5/16	10		PU8	10		
	NPU3/8	10		PU10	10		
	NPU1/2	10		PU12	10		
NPY Union "Y" 	NPY5/32	10	PY Union "Y" 	PY4	10		
	NPY1/4	10		PY6	10		
	NPY5/16	10		PY8	10		
	NPY3/8	10		PY10	10		
	NPY1/2	10		PY12	10		
NPM Bulkhead union 	NPM5/32	10	PM Bulkhead union 	PM4	10		
	NPM1/4	10		PM6	10		
	NPM5/16	10		PM8	10		
	NPM3/8	10		PM10	10		
	NPM1/2	10		PM12	10		
NPZ Bulkhead union 	NPZ5/32	10	PZ Bulkhead union 	PZ4	10		
	NPZ1/4	10		PZ6	10		
	NPZ5/16	10		PZ8	10		
	NPZ3/8	10		PZ10	10		
	NPZ1/2	10		PZ12	10		
NPE Union tee 	NPE5/32	10	PE Union tee 	PE4	10		
	NPE1/4	10		PE6	10		
	NPE5/16	10		PE8	10		
	NPE3/8	10		PE10	10		
	NPE1/2	10		PE12	10		
NPV Union elbow 	NPV5/32	10	PV Union elbow 	PV4	10		
	NPV1/4	10		PV6	10		
	NPV5/16	10		PV8	10		
	NPV3/8	10		PV10	10		
	NPV1/2	10		PV12	10		
NPP Plug 	NPP5/32	10	PP Plug 	PP4	10		
	NPP1/4	10		PP6	10		
	NPP5/16	10		PP8	10		
	NPP3/8	10		PP10	10		
	NPP1/2	10		PP12	10		
NPLM Bulkhead male elbow 	NPLM5/32	1/2-20UNF	10	PLM Bulkhead male elbow 	PLM4	M12X1	10
	NPLM1/4	9/16-18UNF	10		PLM6	M14X1	10
	NPLM5/16	5/8-18UNF	10		PLM8	M16X1	10
	NPLM3/8	7/8-14UNF	10		PLM10	M20X1	10
	NPLM1/2	7/8-14UNF	10		PLM12	M22X1	10

Tube-tube type

Model+ΦDA-ΦDB									
	ΦDA(Inch)	ΦDB(Inch)	PCS/bag	ΦDA(Metric)	ΦDB(Metric)	PCS/bag			
NPG Different diameter straight 	ΦDA	ΦDB	10	NPG1/4-5/32	PG6-4	10			
							NPG5/16-1/4	PG8-4	10
							NPG3/8-1/4	PG8-6	10
							NPG3/8-5/16	PG10-6	10
							NPG1/2-5/16	PG10-8	10
PEW Different diameter tee 	ΦDA	ΦDB	10	NPEW1/4-5/32	PEW6-4	10			
							NPEW5/16-1/4	PEW8-6	10
							NPEW3/8-5/16	PEW10-8	10
							NPEW1/2-5/16	PEW12-8	10
							NPEW1/2-3/8	PEW12-10	10
NPEG Different diameter tee 	ΦDA	ΦDB	10	NPEG1/4-5/32	PEG6-4	10			
							NPEG5/16-1/4	PEG8-6	10
							NPEG3/8-5/16	PEG10-8	10
							NPEG1/2-5/16	PEG12-8	10
							NPEG1/2-3/8	PEG12-10	10
NPKG Reducer triple branch union 	ΦDA	ΦDB	5	NPKG1/4-5/32	PKG6-4	5			
							NPKG5/16-1/4	PKG8-6	5
							NPKG3/8-5/16	PKG10-8	5
NPHD Universal reducer four branch union 	ΦDA	ΦDB	2	NPHD5/16-1/4	PHD8-6	2			
							NPHD3/8-5/16	PHD10-8	2



Tube-tube type

Model+ΦDA-ΦDB					
ΦDA(Inch)ΦDB(Inch)		PCS/bag	ΦDA(Metric)ΦDB(Metric)		PCS/bag
NPGJ Plug-in reducer 	NPGJ1/4-5/32	10	PGJ Plug-in reducer 	PGJ6-4	10
	NPGJ5/16-1/4	10		PGJ8-4	10
	NPGJ3/8-1/4	10		PGJ8-6	10
	NPGJ3/8-5/16	10		PGJ10-6	10
	NPGJ1/2-5/16	10		PGJ10-8	10
	NPGJ1/2-3/8	10		PGJ12-8	10
					PGJ12-10
ΦDA(Inch)ΦDB(Inch)		PCS/bag	ΦDA(Metric)ΦDB(Metric)		PCS/bag
NPZG Different diameter cross 	NPZG1/4-5/32	10	PZG Different diameter cross 	PZG6-4	10
	NPZG5/16-1/4	10		PZG8-6	10
	NPZG3/8-5/16	10		PZG10-8	10
	NPZG1/2-3/8	10		PZG12-10	10
ΦDA(Inch)ΦDB(Inch)		PCS/bag	ΦDA(Metric)ΦDB(Metric)		PCS/bag
NPYW Different diameter union "Y" 	NPYW1/4-5/32	10	PYW Different diameter union "Y" 	PYW6-4	10
	NPYW5/16-1/4	10		PYW8-6	10
	NPYW3/8-5/16	10		PYW10-8	10
	NPYW1/2-5/16	10		PYW12-8	10
	NPYW1/2-3/8	10		PYW12-10	10
ΦDA(Inch)ΦDB(Inch)		PCS/bag	ΦDA(Metric)ΦDB(Metric)		PCS/bag
NPHK Universal reducer triple branchunion 	NPHK5/16-1/4	2	PHK Universal reducer triple branchunion 	PHK8-6	2
	NPHK3/8-5/16	2		PHK10-8	2

Model+ΦD+R							
ΦD(Inch)R(NPT thread)		PCS/bag	ΦD(Metric)R(PT thread)		PCS/bag		
NPTL Speed Control valve 	NPTL5/32-U10□	2	PTL-M Mini Speed Control valve 	PTL401□-M	2		
	NPTL5/32-1/8□	2		PTL601□-M	2		
	NPTL1/4-U10□	2					
	NPTL1/4-1/8□	2					
	NPTL1/4-1/4□	2					
	NPTL1/4-3/8□	2					
	NPTL5/16-1/8□	2					
	NPTL5/16-1/4□	2					
	NPTL5/16-3/8□	2					
	NPTL5/16-1/2□	2					
	NPTL3/8-1/4□	2					
	NPTL3/8-3/8□	2					
	NPTL3/8-1/2□	2					
	NPTL1/2-3/8□	2					
	NPTL1/2-1/2□	2					
					PTL Speed Control valve 	PTL601□	2
					PTL602□	2	
			PTL603□	2			
			PTL801□	2			
			PTL802□	2			
			PTL803□	2			
			PTL804□	2			
			PTL1002□	2			
			PTL1003□	2			
			PTL1004□	2			
			PTL1203□	2			
			PTL1204□	2			

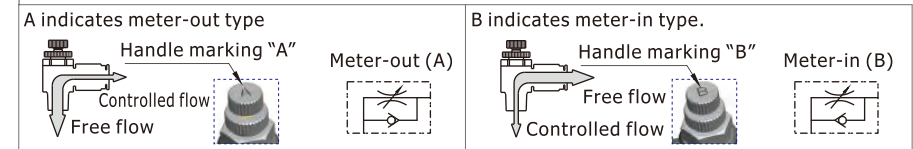

[Note] "□" stands for A or B

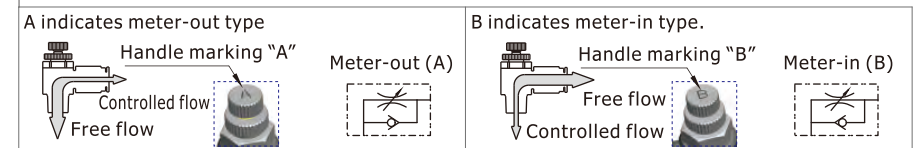

Model+ΦD+R					
ΦD(Inch)R(NPT thread)		PCS/bag	ΦD(Metric)R(PT thread)		PCS/bag
NPSS Speed Control valve 	NPSS5/32-U10□	2	PSS Speed Control valve 	PSS601□	2
	NPSS1/4-1/8□	2		PSS602□	2
	NPSS1/4-1/4□	2		PSS801□	2
	NPSS5/16-1/8□	2		PSS802□	2
	NPSS5/16-1/4□	2		PSS1002□	2
	NPSS3/8-1/4□	2		PSS1003□	2
	NPSS3/8-3/8□	2		PSS1203□	2
	NPSS1/2-3/8□	2		PSS1204□	2
	NPSS1/2-1/2□	2			

[Note] "□" stands for A or B





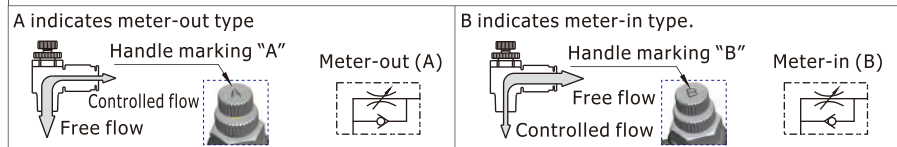

Model+ΦD			Model+ΦD+R			
	ΦD(Inch)	PCS/bag	ΦD(Metric)R(PT thread)	PCS/bag		
NPSA Speed Control valve 	NPSA5/32	2	PSL Speed Control valve 	PSL401□	2	
	NPSA1/4	2		PSL601□	2	
	NPSA5/16	2		PSL602□	2	
	NPSA3/8	2		PSL603□	2	
	NPSA1/2	2		PSL801□	2	
					PSL802□	2
					PSL803□	2
					PSL804□	2
					PSL1002□	2
					PSL1003□	2
					PSL1004□	2
					PSL1203□	2
					PSL1204□	2

	ΦD(Inch)	PCS/bag
NPHV Finger valve 	NPHV1/4□	2
	NPHV5/16□	2
	NPHV3/8□	2
	NPHV1/2□	2

[Note] "□" stands for A or B





Model+R			Model+R			
	R(NPT thread)	PCS/bag	R(PT thread)	PCS/bag		
NBSL Silencers 	NBSLU10	10	BSL Silencers 	BSL01	10	
	NBSL1/8	10		BSL02	10	
	NBSL1/4	10		BSL03	10	
	NBSL3/8	10		BSL04	10	
	NBSL1/2	10				
					BSLM01	10
					BSLM02	10
					BSLM03	10
					BSLM04	10

	R(NPT thread)	PCS/bag	R(PT thread)	PCS/bag		
NBSLM Silencers 	NBSLMU10	10	BSLM Silencers 	BSLM01		
	NBSLM1/8	10		BSLM02		
	NBSLM1/4	10		BSLM03		
	NBSLM3/8	10		BSLM04		
	NBSLM1/2	10				
					BESL01	10
					BESL02	10
					BESL03	10
					BESL04	10

	R(NPT thread)	PCS/bag	R(PT thread)	PCS/bag
NBESL Silencers 	NBESL1/8	10	BESL Silencers 	BESL01
	NBESL1/4	10		BESL02
	NBESL3/8	10		BESL03
	NBESL1/2	10		BESL04

	R(PT thread)	PCS/bag
PAL\PALM Silencers 	PAL01	10
	PAL02	10
	PAL03	10
	PAL04	10
	PALM01	10
	PALM02	10

Model+ΦO.D+ΦI.D+Length+Color					
	ΦO.D(Inch)ΦI.D(Inch)	Length	ΦO.D(Metric)ΦI.D(Metric)	Length	
NUE95A Polyurethane re-coil hosepart 	NUE95A1/8X5/64-□□	100/200	US98A,UE95A Polyurethane re-coil hosepart 	US98A040025□□	100/200
	NUE95A5/32X3/32-□□	100/200		US98A060040□□	100/200
	NUE95A1/4X5/32-□□	100		US98A080050□□	100
	NUE95A5/16X1/5-□□	100		US98A100065□□	100
	NUE95A3/8X1/4-□□	100		US98A120080□□	100
	NUE95A1/2X1/3-□□	100		US98A160110□□	100
					US98A080055□□
			US98A080060□□	100	
			US98A100080□□	100	
			US98A120100□□	100	
			US98A160120□□	100	
			UE95A040025□□	20/100/200	
			UE95A060040□□	20/100/200	
			UE95A080050□□	20/100	
			UE95A100065□□	20/100	
			UE95A120080□□	20/100	
			UE95A080055□□	20/100	

[Note] "□□" stands for Color.

- BU: Blue
- BK: Black
- GE: Orange
- C: Clear
- WH: White
- CB: Clear Blue
- R: Red
- Y: Yellow
- GA: Gray
- GN: Green
- BR: Brown
- CR: Clear Red
- CG: Clear Green
- CY: Clear Yellow
- CE: Clear Orange

Model+ΦO.D+ΦI.D+Length+Color		
	ΦO.D(Metric) ΦI.D(Metric)	Length
PA6\PA12 Nylon tube 	PA6040025□□	200
	PA6060040□□	100
	PA6080060□□	100
	PA6100075□□	100
	PA6120090□□	100
	PA12040025□□	200
	PA12060040□□	100
	PA12080060□□	100
	PA12100075□□	100
	PA12120090□□	100

[Note] "□□" stands for Color.

- BU: Blue
- BK: Black
- GE: Orange
- N: Clear
- WH: White
- GN: Green
- R: Red
- Y: Yellow

[Note] "□□" stands for Color.

- BU: Blue
- BK: Black
- GE: Orange
- C: Clear
- WH: White
- CB: Clear Blue
- R: Red
- Y: Yellow
- GA: Gray
- GN: Green
- BR: Brown
- CR: Clear Red
- CG: Clear Green
- CY: Clear Yellow
- CE: Clear Orange